

# INSTRUCTIONS



## WEATHERBRAKE

2175

FITS

MF 1533, 1540, 1635,  
1643, 1648, 1652, 1655, 1660  
Challenger: MT 265B, MT 275B  
AGCO Allis: ST 34A, ST41A

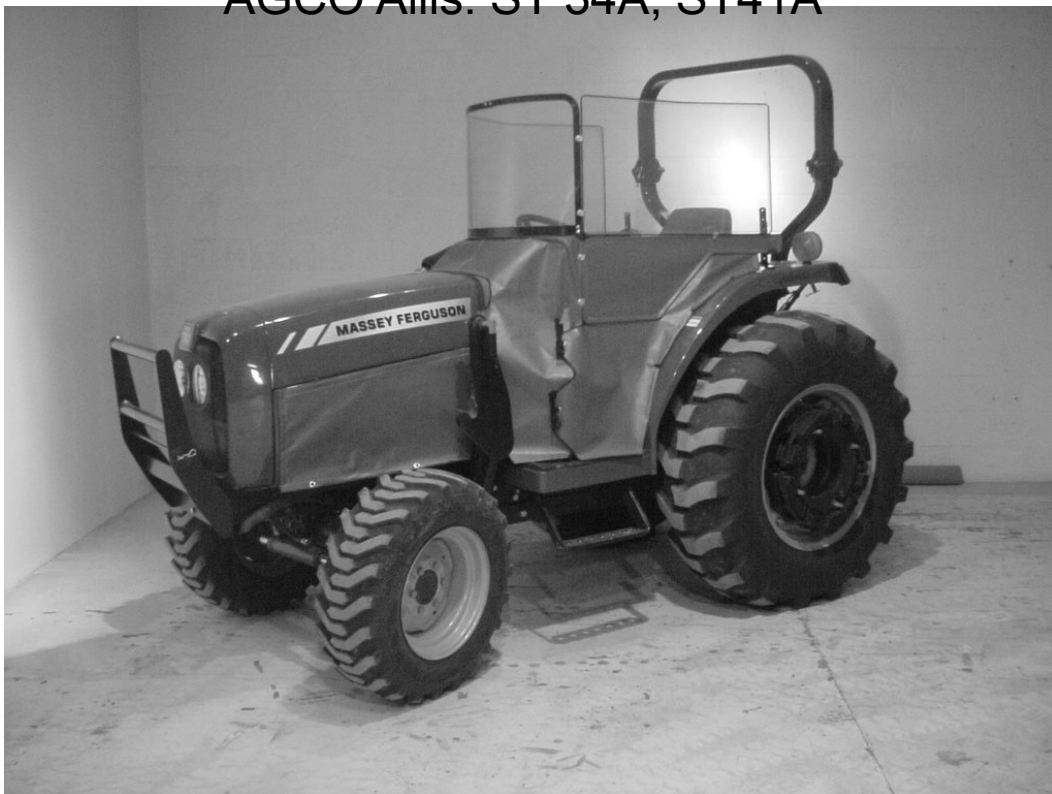

**General Offices**  
1132 W. 1ST STREET  
McPherson, KS 67460  
Phone: (620) 241-3513  
Web: [www.femcomfg.com](http://www.femcomfg.com)

Form No. 286324500 / 12-2005

# IMPORTANT

READ AND UNDERSTAND ALL INSTRUCTIONS BEFORE MOUNTING WEATHER BRAKE. DO NOT TIGHTEN HARDWARE UNTIL INSTRUCTED TO DO SO

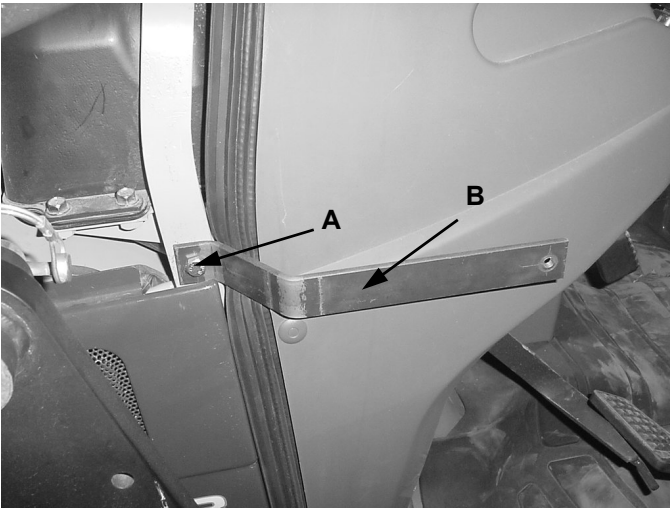

## YOKE BRACE

1. Lift hood and remove bolt (A)
2. Attach yoke brace (B) using bolt removed
3. Yoke brace is to be parallel with tractor. Tighten bolt.
4. Repeat procedure for the other side.

## YOKE BRACKET

1. Attach yoke bracket (A) to yoke braces using two (2) 1/4" x 3/4" bolts and nuts.
2. Yoke bracket is to be 90° to yoke braces. Tighten bolts.



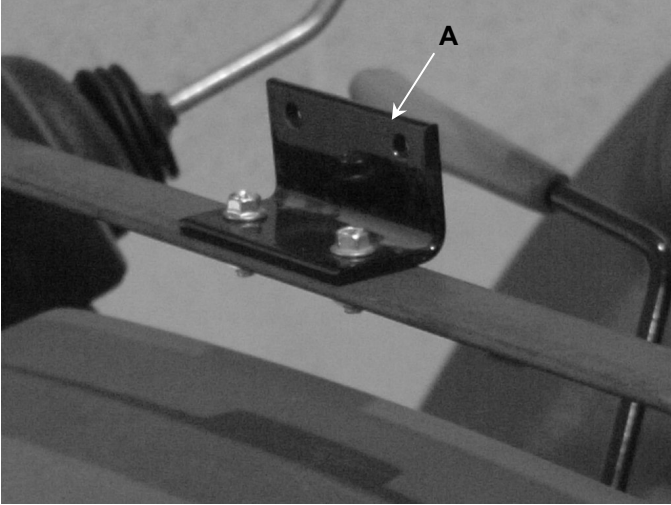

### YOKE BRACKET TAB

1. Attach yoke bracket tab (A) to yoke bracket so holes 3/8" from top edge point up, using two (2) 1/4" x 3/4" bolts and nuts.
2. Tighten bolts.

### DOOR POST HOLE

1. Drill a 9/32" diameter hole into foot rest at location (A)



### DOOR POST

1. Attach door post (A) to foot rest using one (1) 1/4" x 1" bolt, fender washer, and nut.

## MOTOR COVER

1. Arrange motor cover (A) over hood of tractor.
2. Slide 3" hem of motor cover down over top of door post.

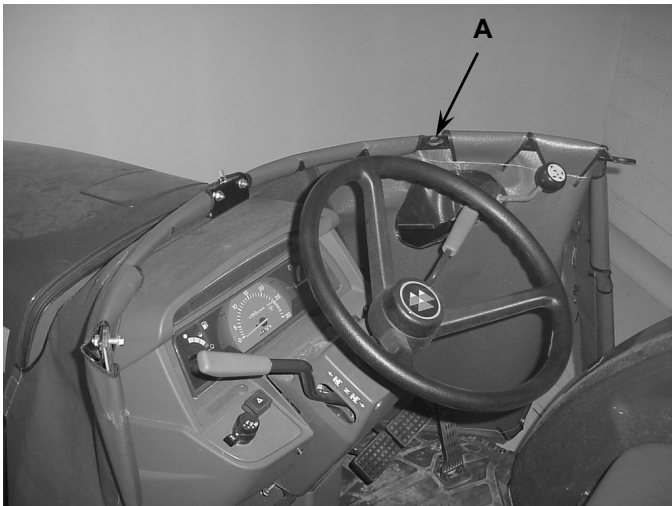

## YOKE

1. Insert yoke (A) into top 3" hem of motor cover.
2. Attach yoke to yoke bracket using two (2) 1/4" x 3/4" bolts and nuts.
3. Attach end of yoke to door post using one (1) 1/4" x 1" bolt and nut. Bolt head inside, nut outside.

## SIDE ARM

1. Slide side arm (A) into side 3" hem of motor cover.
2. Attach side arm to yoke using one (1) 3/8" x 1" bolt and nut. Head of bolt up, nut down
3. Attach side arm bracket (B) to side arm using two (2) 1/4" x 3/4" bolts and nuts. **NOTE: Door post is to be straight up and down, yoke and side arm parallel to tractor. Make adjustments if necessary.**
4. Drill a 9/32" diameter hole in fender and attach side arm bracket using one (1) 1/4" x 1" bolts, fender washer and nut.
5. Tighten bolts.

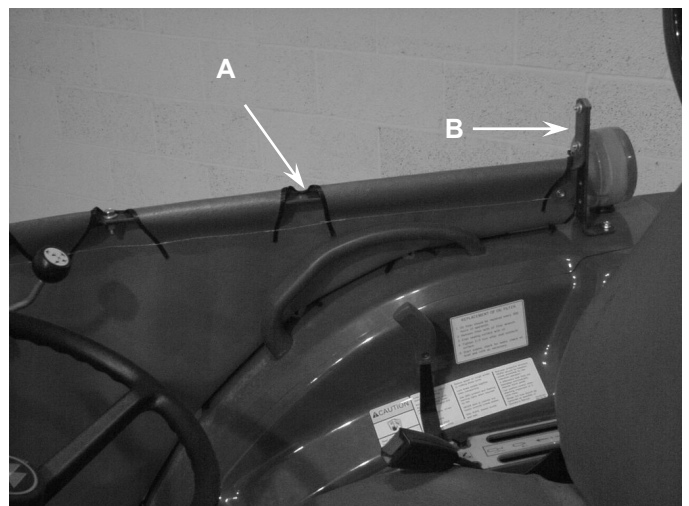





**DUAL LOCK®** is a registered trademark of 3M Co.

1. Cut the plastic Dual Lock into 2" lengths.
2. The surface must be cleaned with a mild detergent to assure proper application of Dual Lock strips.
3. Apply cut Dual Lock to all Dual Lock sewn to the motor cover.
4. Arrange the motor cover to the tractor. Peel the backing from the Dual Lock and apply to the tractor. Repeat this procedure for all Dual Lock

## TIE STRAPS

### IMPORTANT

CLOTH STRAPS ARE NOT TO BE ATTACHED TO ANY MOVING, ROTATING, OR HEAT GENERATING POINTS OF TRACTOR. ANY EXCESS CLOTH STRAP IS TO BE CUT OFF.

1. Thread cloth strap through grommets at bottom of motor cover and tie.
2. Route cloth straps to other side or to a point on tractor and tie.

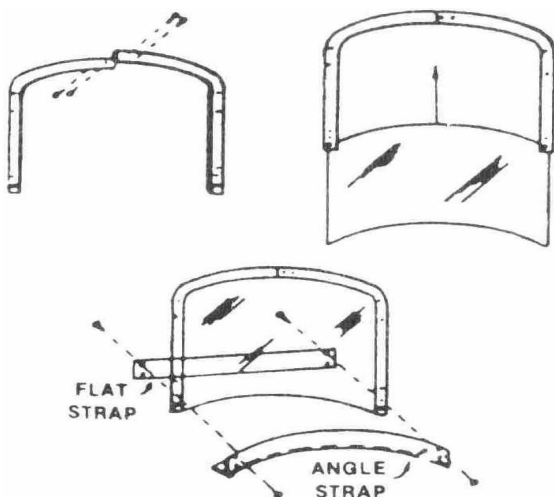

## WINDSHIELD ASSEMBLY

1. Attach left and right window frames using two (2) #10 x 1/2" bolts and nuts.
2. Slide glass in channel of windshield frame.
3. Attach flat strip and angle strip to windshield frame using two (2) #10 x 1/2" bolts and nuts in second holes only.
4. **TIGHTEN BOLTS.**

## WINDSHIELD ATTACHMENT

1. Remove nut from yoke and door post and attach assembled windshield.
2. Attach assembled windshield to outside of yoke with nut removed and 1/4" x 1" bolt and nut to other side of windshield
3. Tighten all bolts.

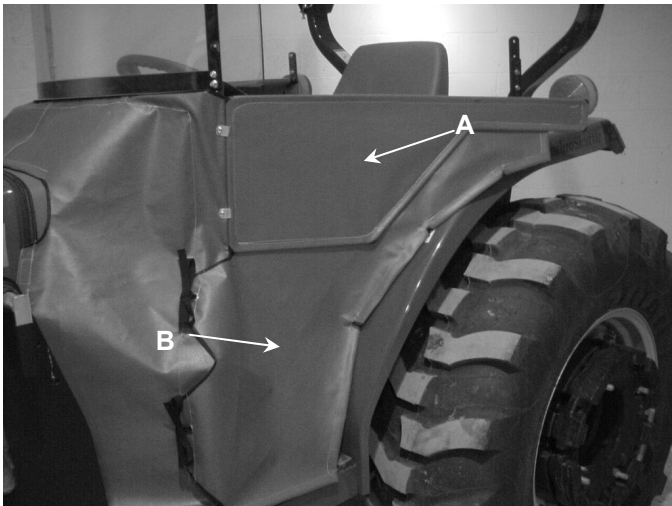
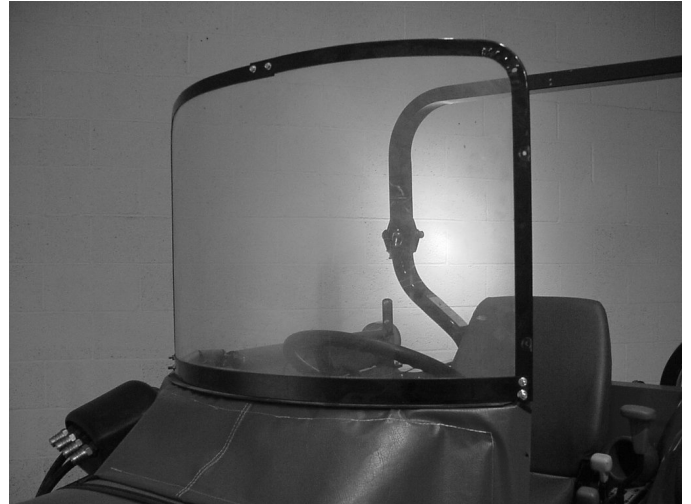

## DOORS

1. Locate holes in door post and cut holes in fabric.
2. Hold door (A) to door post and bottom of windshield.
3. Mark location of holes in door post to door
4. Cut 5/8" slots next to wire frame of door and attach to door post using two (4) #10 x 3/4" bolts, clips, and nuts.
5. Tie door flap (B) to motor cover.
6. TIGHTEN ALL BOLTS.

## LEFT WINDOW

1. Mark location of holes in windshield to left window (A).
2. Cut 5/8" slots next to wire frame of left window and attach to windshield using two (2) #10 x 3/4 bolts and nuts.
3. At location (B) cut 5/8" slots inside window and top of door and attach using one (1) #10 x 3/4" bolt, nut & clip.
4. Tighten bolts.

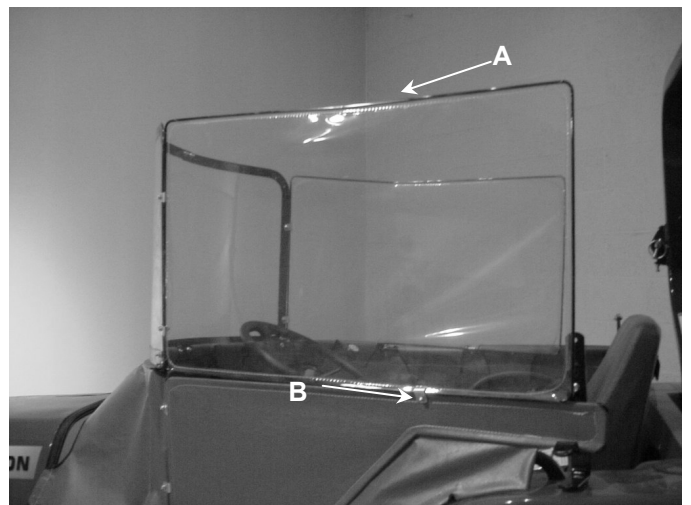



## LEFT WINDOW

1. Mark location of holes in windshield to left window (A).
2. Cut 5/8" slots next to wire frame of left window and attach to windshield using two (2) #10 x 3/4 bolts and nuts.
3. About 6" from back of left window at location (B) cut 5/8" slots in left window and door and attach using one (1) #10 x 3/4" bolt, nut & clip.
4. Tighten bolts.

## RIGHT WINDOW

1. Right window is to be bent to conform to side arm by placing on a table and bending by hand.
2. Using same procedure as left window, attach right window to windshield and side arm using three (3) #10 x 3/4" bolts, clips and nuts.
3. Tighten bolts.



## DOOR LATCH

1. Assemble door latches as shown using two (2) 1/4" x 3/4" bolts and nuts.
2. Position under bottom rear of door.
3. Door is to be set firmly in loop of door latch. Change position up or down with adjustment holes if necessary.
4. Mark location for one (1) of the two (2) holes and drill one (1) 9/32" diameter hole.
5. Attach to fender using one (1) 1/4" x 1" bolt and nut.
6. Tighten all bolts.

## NOTES